



SGM811/SGM812 Microprocessor Supervisory Circuits with Manual Reset Input

GENERAL DESCRIPTION

The SGM811/SGM812 supervisory circuits monitor the power supply voltage in microprocessor and digital systems. The SGM811/SGM812 are designed to monitor eight different voltages; these voltages have been selected for the effective monitoring of 1.8V, 2.5V, 3V, 3.3V and 5V supply voltage levels.

They provide a reset output during power-up, power-down and brownout conditions. On power-up, an internal timer holds reset asserted for 240ms. This holds the microprocessor in a reset state until conditions have stabilized. The nRESET output remains operational with V_{CC} as low as 1V. The SGM811 provides an active low reset signal (nRESET) while the SGM812 provides an active high signal (RESET) output.

Included in this circuit is a manual reset input. The manual reset function is very useful, especially if the circuit in which the SGM811/SGM812 is operating enters into a state that can only be detected by the user. Allowing the user to reset a system manually can reduce the damage or danger that could otherwise be caused by an out-of-control or locked system. The devices come in SOT-143 and SOT-23-5 packages.

FEATURES

- Superior Upgrade for MAX811/MAX812 and ADM811/ADM812
- Full Specified over Temperature
- Low Power Consumption: 13 μ A (TYP)
- Precision Voltage Monitor: 1.8V, 2.5V, 3V, 3.3V and 5V Options
- Reset Assertion Down to 1V V_{CC}
- 150ms (MIN) Power-On Reset Logic Low nRESET Output (SGM811) Logic High RESET Output (SGM812)
- Manual Reset Input
- Available in Green SOT-143 and SOT-23-5 Packages

APPLICATIONS

Microprocessor Systems
Controllers
Intelligent Instruments
Automotive Systems
Safety Systems
Portable Instruments

TYPICAL APPLICATION

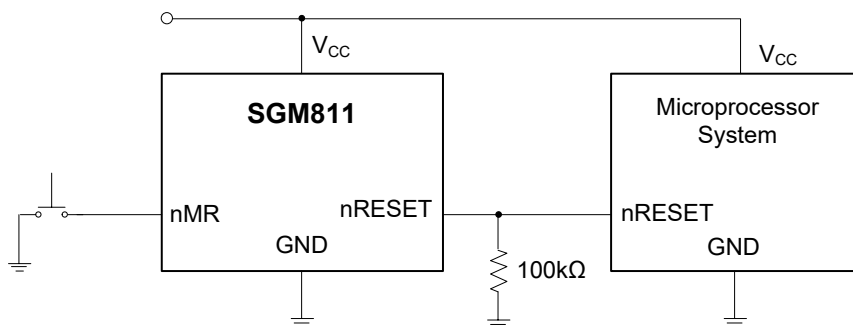

PACKAGE/ORDERING INFORMATION

ORDERING NUMBER	RESET THRESHOLD (V)	PACKAGE DESCRIPTION	SPECIFIED TEMPERATURE RANGE	PACKAGE MARKING	PACKING OPTION
SGM811-LXN5/TR	4.63	SOT-23-5	-40°C to +125°C	811L	Tape and Reel, 3000
SGM811-MXN5/TR	4.38	SOT-23-5	-40°C to +125°C	811M	Tape and Reel, 3000
SGM811-JXN5/TR	4.00	SOT-23-5	-40°C to +125°C	811J	Tape and Reel, 3000
SGM811-TXN5/TR	3.08	SOT-23-5	-40°C to +125°C	811T	Tape and Reel, 3000
SGM811-SXN5/TR	2.93	SOT-23-5	-40°C to +125°C	811S	Tape and Reel, 3000
SGM811-RXN5/TR	2.63	SOT-23-5	-40°C to +125°C	811R	Tape and Reel, 3000
SGM811-ZXN5/TR	2.32	SOT-23-5	-40°C to +125°C	811Z	Tape and Reel, 3000
SGM811-LXKA4/TR	4.63	SOT-143	-40°C to +125°C	811L	Tape and Reel, 3000
SGM811-MXKA4/TR	4.38	SOT-143	-40°C to +125°C	811M	Tape and Reel, 3000
SGM811-JXKA4/TR	4.00	SOT-143	-40°C to +125°C	811J	Tape and Reel, 3000
SGM811-TXKA4/TR	3.08	SOT-143	-40°C to +125°C	811T	Tape and Reel, 3000
SGM811-SXKA4/TR	2.93	SOT-143	-40°C to +125°C	811S	Tape and Reel, 3000
SGM811-RXKA4/TR	2.63	SOT-143	-40°C to +125°C	811R	Tape and Reel, 3000
SGM811-ZXKA4/TR	2.32	SOT-143	-40°C to +125°C	811Z	Tape and Reel, 3000
SGM811-XXKA4/TR	1.63	SOT-143	-40°C to +125°C	811X	Tape and Reel, 3000
SGM812-LXN5/TR	4.63	SOT-23-5	-40°C to +125°C	812L	Tape and Reel, 3000
SGM812-MXN5/TR	4.38	SOT-23-5	-40°C to +125°C	812M	Tape and Reel, 3000
SGM812-JXN5/TR	4.00	SOT-23-5	-40°C to +125°C	812J	Tape and Reel, 3000
SGM812-TXN5/TR	3.08	SOT-23-5	-40°C to +125°C	812T	Tape and Reel, 3000
SGM812-SXN5/TR	2.93	SOT-23-5	-40°C to +125°C	812S	Tape and Reel, 3000
SGM812-RXN5/TR	2.63	SOT-23-5	-40°C to +125°C	812R	Tape and Reel, 3000
SGM812-ZXN5/TR	2.32	SOT-23-5	-40°C to +125°C	812Z	Tape and Reel, 3000
SGM812-LXKA4/TR	4.63	SOT-143	-40°C to +125°C	812L	Tape and Reel, 3000
SGM812-MXKA4/TR	4.38	SOT-143	-40°C to +125°C	812M	Tape and Reel, 3000
SGM812-JXKA4/TR	4.00	SOT-143	-40°C to +125°C	812J	Tape and Reel, 3000
SGM812-TXKA4/TR	3.08	SOT-143	-40°C to +125°C	812T	Tape and Reel, 3000
SGM812-SXKA4/TR	2.93	SOT-143	-40°C to +125°C	812S	Tape and Reel, 3000
SGM812-RXKA4/TR	2.63	SOT-143	-40°C to +125°C	812R	Tape and Reel, 3000
SGM812-ZXKA4/TR	2.32	SOT-143	-40°C to +125°C	812Z	Tape and Reel, 3000

Green (RoHS & HSF): SG Micro Corp defines "Green" to mean Pb-Free (RoHS compatible) and free of halogen substances. If you have additional comments or questions, please contact your SGMICRO representative directly.

ABSOLUTE MAXIMUM RATINGS

(Typical values are at T_A = +25°C, unless otherwise noted.)
Terminal Voltage (With Respect to Ground)
V_{CC}.....-0.3V to 6V
All Other Inputs.....-0.3V to V_{CC} + 0.3V
Input Current
V_{CC}, nMR.....20mA
Output Current
RESET, nRESET.....20mA
Power Dissipation, P_D @ T_A = +25°C
SOT-23-5.....0.4W
SOT-143.....0.32W
Operating Temperature Range.....-40°C to +125°C
Junction Temperature.....+150°C
Storage Temperature Range.....-65°C to +150°C
Lead Temperature (Soldering, 10s).....+260°C
ESD Susceptibility
HBM.....4000V
MM.....400V

OVERSTRESS CAUTION

Stresses beyond those listed in Absolute Maximum Ratings may cause permanent damage to the device. Exposure to absolute maximum rating conditions for extended periods may affect reliability. Functional operation of the device at any conditions beyond those indicated in the Recommended Operating Conditions section is not implied.

ESD SENSITIVITY CAUTION

This integrated circuit can be damaged by ESD if you don't pay attention to ESD protection. SGMICRO recommends that all integrated circuits be handled with appropriate precautions. Failure to observe proper handling and installation procedures can cause damage. ESD damage can range from subtle performance degradation to complete device failure. Precision integrated circuits may be more susceptible to damage because very small parametric changes could cause the device not to meet its published specifications.

DISCLAIMER

SG Micro Corp reserves the right to make any change in circuit design, or specifications without prior notice.

PIN CONFIGURATIONS

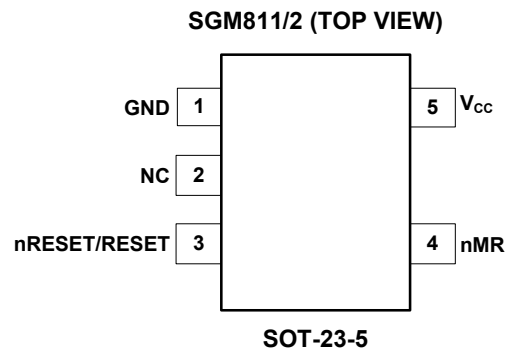
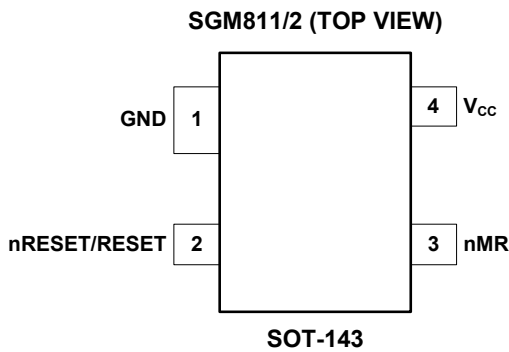

PIN DESCRIPTION

NAME	PIN NUMBER				FUNCTION
	SGM811		SGM812		
	SOT-143	SOT-23-5	SOT-143	SOT-23-5	
GND	1	1	1	1	Ground
NC	—	2	—	2	No Connect.
nRESET	2	3	—	—	Active Low Logic Output. nRESET remains low while V _{CC} is below the reset threshold or when nMR is low; nRESET then remains low for at least 150ms after V _{CC} rises above the reset threshold.
RESET	—	—	2	3	Active High Logic Output. RESET remains high while V _{CC} is below the reset threshold or when nMR is low; RESET then remains high for 240ms (TYP) after V _{CC} rises above the reset threshold.
nMR	3	4	3	4	Manual Reset Input Pin. This active low debounced input will ignore input pulses of 100ns or less (TYP) and is guaranteed to accept input pulses of greater than 10µs. Leave floating when not used.
V _{CC}	4	5	4	5	Power Supply Voltage. Power supply voltage that is monitored.

ELECTRICAL CHARACTERISTICS

(V_{CC} = 5V for L/M/J Models, 3.3V for T/S Models, 3V for R Model, 2.5V for Z Model, 1.8V for X Model, unless otherwise noted.)

PARAMETER	CONDITIONS	MIN	TYP	MAX	UNITS
SUPPLY					
Voltage	T _A = 0°C to +70°C	1.0		5.5	V
	T _A = -40°C to +125°C	1.2		5.5	V
Current	V _{CC} < 5.5V, SGM81_L/M/J, T _A = +25°C		17	30	μA
	V _{CC} < 5.5V, SGM81_L/M/J, T _A = -40°C to +125°C			50	μA
	V _{CC} < 3.6V, SGM81_R/S/T/Z/X, T _A = +25°C		13	25	μA
	V _{CC} < 3.6V, SGM81_R/S/T/Z/X, T _A = -40°C to +125°C			45	μA
RESET VOLTAGE THRESHOLD					
SGM81_L	T _A = +25°C	4.537	4.63	4.723	V
	T _A = -40°C to +125°C	4.40		4.86	V
SGM81_M	T _A = +25°C	4.292	4.38	4.468	V
	T _A = -40°C to +125°C	4.16		4.56	V
SGM81_J	T _A = +25°C	3.92	4.00	4.08	V
	T _A = -40°C to +125°C	3.8		4.2	V
SGM81_T	T _A = +25°C	3.003	3.08	3.157	V
	T _A = -40°C to +125°C	2.92		3.23	V
SGM81_S	T _A = +25°C	2.857	2.93	3.003	V
	T _A = -40°C to +125°C	2.78		3.08	V
SGM81_R	T _A = +25°C	2.564	2.63	2.696	V
	T _A = -40°C to +125°C	2.50		2.76	V
SGM81_Z	T _A = +25°C	2.262	2.32	2.378	V
	T _A = -40°C to +125°C	2.22		2.42	V
SGM811-X	T _A = +25°C	1.589	1.63	1.671	V
	T _A = -40°C to +125°C	1.55		1.71	V
Reset Threshold Temperature Coefficient			30		ppm/°C
V _{CC} to RESET/nRESET Delay	V _{CC} = V _{TH} to (V _{TH} - 100mV)		20		μs
Reset Active Timeout Period	T _A = -40°C to +85°C	150	240	560	ms
	T _A = -40°C to +125°C	100		840	ms
MANUAL RESET					
Minimum Pulse Width		10			μs
Glitch Immunity			100		ns
RESET/nRESET Propagation Delay			0.5		μs
Pull-Up Resistance			1		MΩ
The Manual Reset Circuit Will Act On:					
An Input Rising Above	V _{CC} > V _{TH(MAX)} , SGM81_L/M/J	2.3			V
An Input Falling Below	V _{CC} > V _{TH(MAX)} , SGM81_L/M/J			0.8	V
An Input Rising Above	V _{CC} > V _{TH(MAX)} , SGM81_R/S/T/Z/X	0.7 × V _{CC}			V
An Input Falling Below	V _{CC} > V _{TH(MAX)} , SGM81_R/S/T/Z/X			0.25 × V _{CC}	V

ELECTRICAL CHARACTERISTICS (continued)

($V_{CC} = 5V$ for L/M/J Models, $3.3V$ for T/S Models, $3V$ for R Model, $2.5V$ for Z Model, $1.8V$ for X Model, unless otherwise noted.)

PARAMETER	CONDITIONS	MIN	TYP	MAX	UNITS
RESET/nRESET OUTPUT VOLTAGE					
Low (SGM811-R/S/T/Z/X)	$V_{CC} = V_{TH(MIN)}$, $I_{SINK} = 1.2mA$			0.3	V
Low (SGM811-L/M/J)	$V_{CC} = V_{TH(MIN)}$, $I_{SINK} = 3.2mA$			0.4	V
Low (SGM811-R/S/T/Z/X/L/M/J)	$V_{CC} > 1.0V$, $I_{SINK} = 50\mu A$			0.3	V
High (SGM811-R/S/T/Z/X)	$V_{CC} > V_{TH(MAX)}$, $I_{SOURCE} = 500\mu A$	$0.8 \times V_{CC}$			V
High (SGM811-L/M/J)	$V_{CC} > V_{TH(MAX)}$, $I_{SOURCE} = 800\mu A$	$V_{CC} - 1.5$			V
Low (SGM812-R/S/T/Z/X)	$V_{CC} = V_{TH(MAX)}$, $I_{SINK} = 1.2mA$			0.3	V
Low (SGM812-L/M/J)	$V_{CC} = V_{TH(MAX)}$, $I_{SINK} = 3.2mA$			0.4	V
High (SGM812-R/S/T/Z/X/L/M/J)	$1.8V < V_{CC} < V_{TH(MIN)}$, $I_{SOURCE} = 150\mu A$	$0.8 \times V_{CC}$			V

TYPICAL PERFORMANCE CHARACTERISTICS

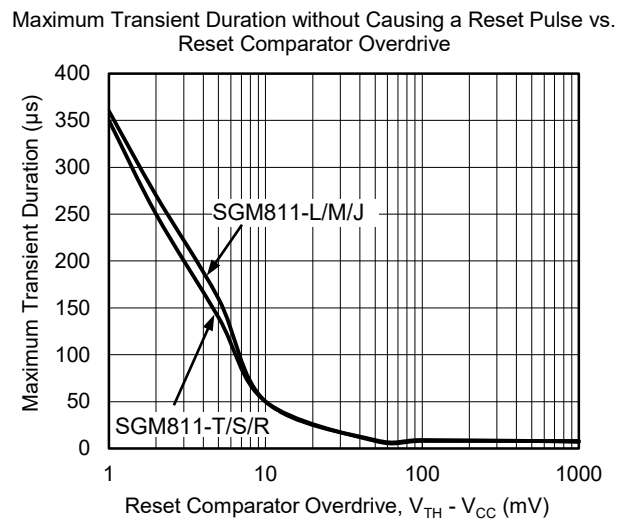
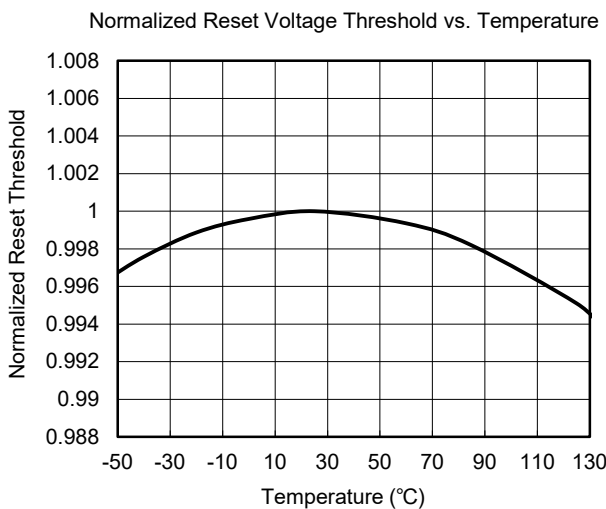
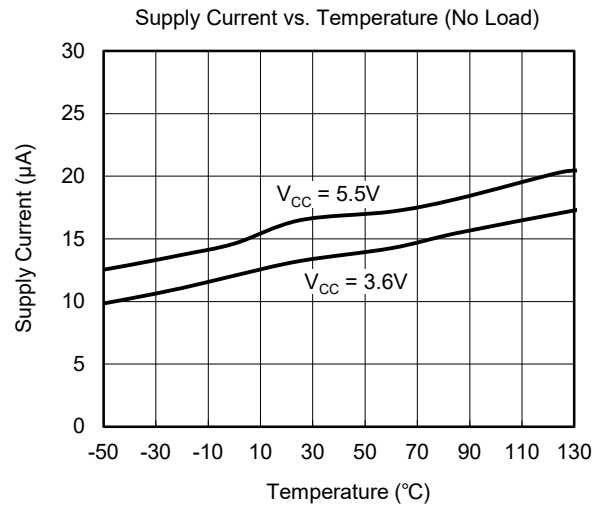
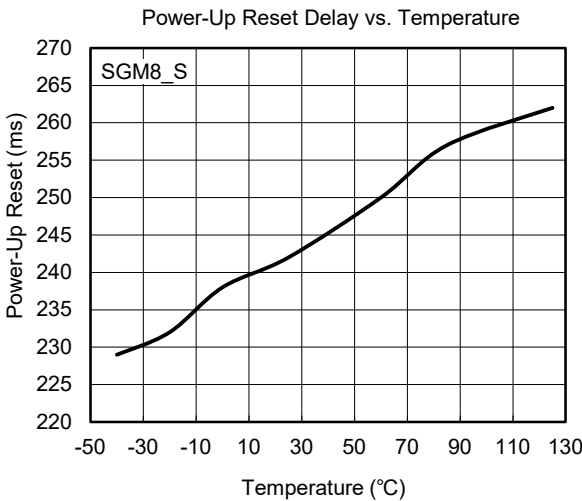
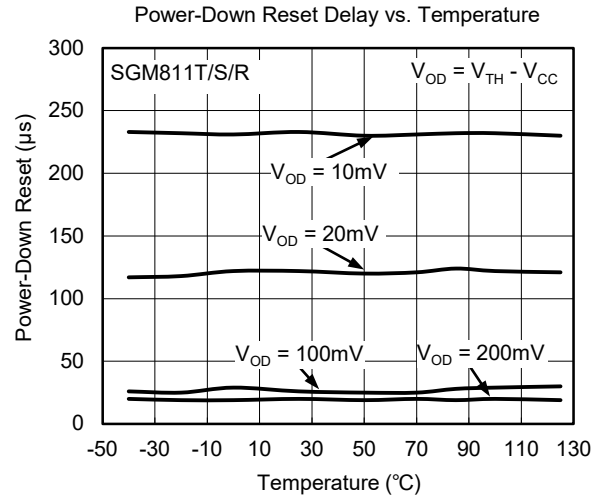
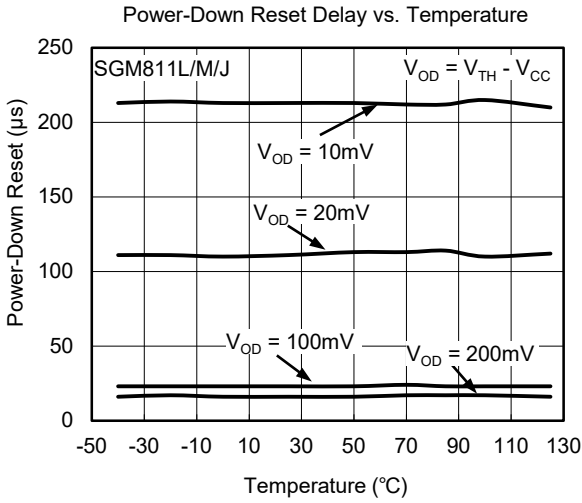

TYPICAL PERFORMANCE CHARACTERISTICS (continued)

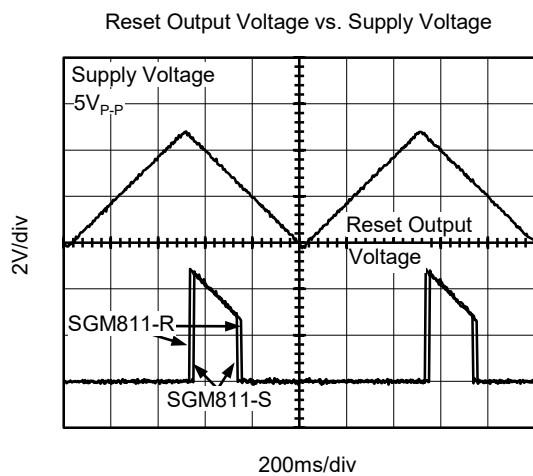

APPLICATION INFORMATION

Manual Reset

Each of the SGM811/SGM812 devices is equipped with a manual reset input. This input is designed to operate in a noisy environment where unwanted glitches could be induced. These glitches could be produced by the bouncing action of a switch contact, or where a manual reset switch may be located some distance away from the circuit (the cabling of which may pick-up noise).

The manual reset input is guaranteed to ignore logically valid inputs that are faster than 100ns and to accept inputs longer in duration than 10µs.

Very Accurate Reset Threshold

Because the SGM811/SGM812 can operate effectively even when there are large degradations of the supply voltages, the possibility of a malfunction during a power failure is greatly reduced. Another advantage of the SGM811/SGM812 is its very accurate internal voltage reference circuit. Combined, these benefits produce an exceptionally reliable microprocessor supervisory circuit.

Ensuring A Valid Reset Output Down to $V_{CC} = 0V$

When V_{CC} falls below 1.0V, the SGM811/SGM812's nRESET no longer sinks current. Therefore, a high impedance CMOS logic input connected to nRESET may drift to undetermined logic levels. To eliminate this problem, a 100kΩ resistor should be connected from nRESET to ground.

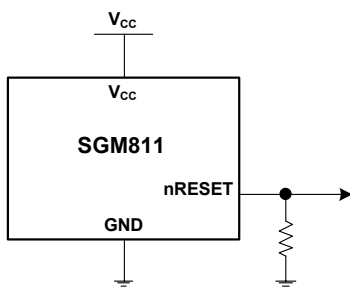

Figure 1. Ensuring a Valid nRESET Output Down to $V_{CC} = 0V$

Reset Output

On power-up and after V_{CC} rises above the reset threshold, an internal timer holds the reset output active for 240ms (TYP). This is intended as a power-on reset signal for the processor. It allows time for both the power supply and the microprocessor to stabilize after power-up. If a power supply brownout or interruption occurs, the reset output is similarly activated and remains active for 240ms (TYP) after the supply recovers. This allows time for the power supply and microprocessor to stabilize.

The SGM811 provides an active low reset output (nRESET) while the SGM812 provides an active high output (RESET). During power-down of the SGM811, the nRESET output remains valid (low) with V_{CC} as low as 1V. This ensures that the microprocessor is held in a stable shutdown condition as the supply falls and also ensures that no spurious activity can occur via the microprocessor as it powers up.

Glitch Immunity

The SGM811/SGM812 contain internal filtering circuitry providing glitch immunity from fast transient glitches on the power supply line.

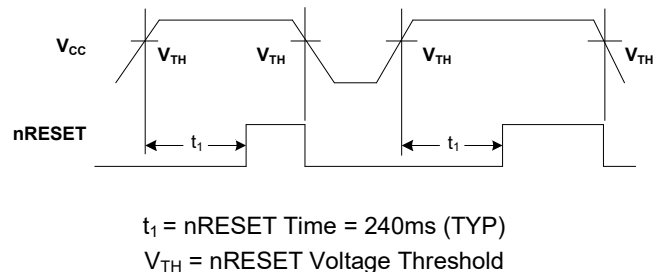

$t_1 = \text{nRESET Time} = 240\text{ms (TYP)}$
 $V_{TH} = \text{nRESET Voltage Threshold}$

Figure 2. Power Fail nRESET Timing

Interfacing to Other Devices Output

The SGM811/SGM812 are designed to integrate with as many devices as possible. One feature of the SGM811/SGM812 is the reset output, which is directly proportional to V_{CC} (this is guaranteed only while V_{CC} is greater than 1V). This enables the part to be used with both 3V and 5V, or any nominal voltage within the minimum and maximum specifications for V_{CC} .

REVISION HISTORY

NOTE: Page numbers for previous revisions may differ from page numbers in the current version.

JANUARY 2015 – REV.B.3 to REV.B.4

Added SGM811-1.63 Option.....All

JANUARY 2013 – REV.B.2 to REV.B.3

Added Recommended Land Pattern Information 10, 11

Added Tape and Reel Information 12, 13

PACKAGE OUTLINE DIMENSIONS

SOT-143

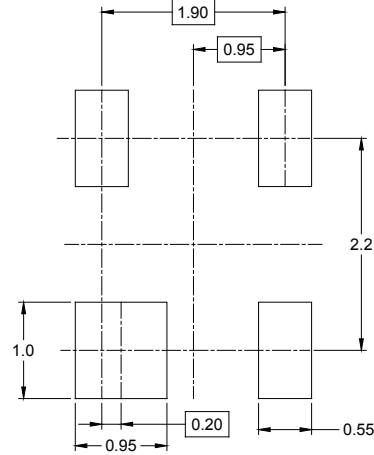
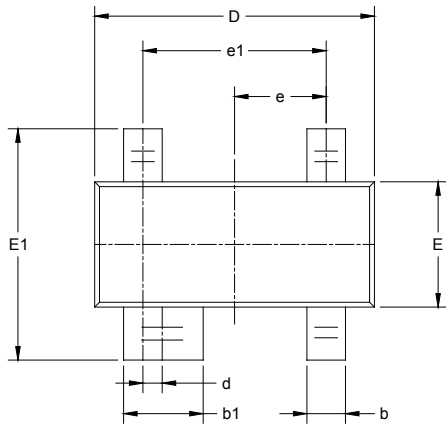

RECOMMENDED LAND PATTERN (Unit: mm)

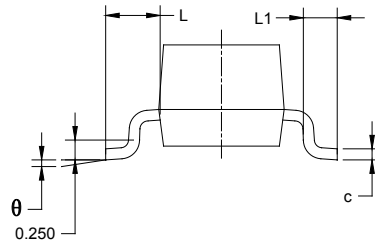
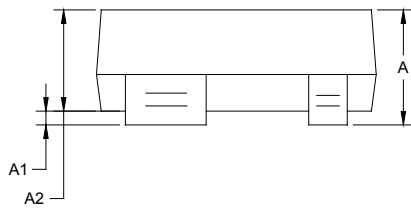

Symbol	Dimensions In Millimeters		Dimensions In Inches	
	MIN	MAX	MIN	MAX
A	0.900	1.150	0.035	0.045
A1	0.000	0.100	0.000	0.004
A2	0.900	1.050	0.035	0.041
b	0.300	0.500	0.012	0.020
b1	0.750	0.900	0.030	0.035
c	0.080	0.150	0.003	0.006
D	2.800	3.000	0.110	0.118
d	0.200 TYP		0.008 TYP	
E	1.200	1.400	0.047	0.055
E1	2.250	2.550	0.089	0.100
e	0.95 TYP		0.037 TYP	
e1	1.800	2.000	0.071	0.079
L	0.55 REF		0.022 REF	
L1	0.300	0.500	0.012	0.020
θ	0°	8°	0°	8°

PACKAGE OUTLINE DIMENSIONS

SOT-23-5

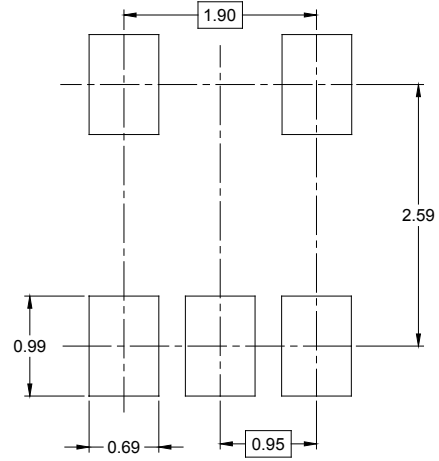
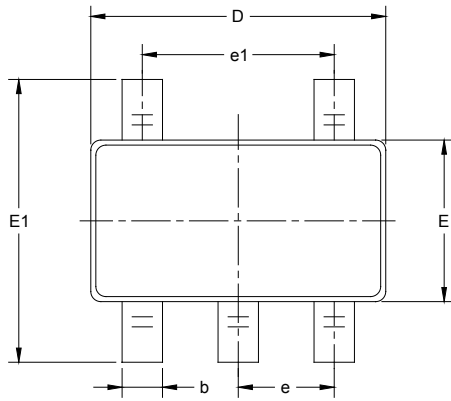

RECOMMENDED LAND PATTERN (Unit: mm)

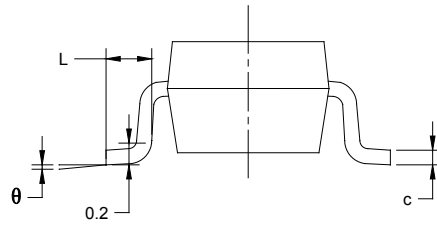
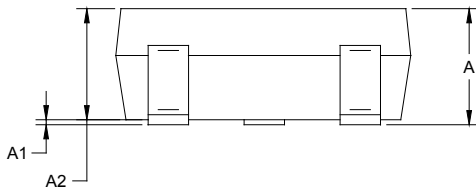

Symbol	Dimensions In Millimeters		Dimensions In Inches	
	MIN	MAX	MIN	MAX
A	1.050	1.250	0.041	0.049
A1	0.000	0.100	0.000	0.004
A2	1.050	1.150	0.041	0.045
b	0.300	0.500	0.012	0.020
c	0.100	0.200	0.004	0.008
D	2.820	3.020	0.111	0.119
E	1.500	1.700	0.059	0.067
E1	2.650	2.950	0.104	0.116
e	0.950 BSC		0.037 BSC	
e1	1.900 BSC		0.075 BSC	
L	0.300	0.600	0.012	0.024
θ	0°	8°	0°	8°

PACKAGE INFORMATION

TAPE AND REEL INFORMATION

REEL DIMENSIONS



TAPE DIMENSIONS



NOTE: The picture is only for reference. Please make the object as the standard.

KEY PARAMETER LIST OF TAPE AND REEL

Package Type	Reel Diameter	Reel Width W1 (mm)	A0 (mm)	B0 (mm)	K0 (mm)	P0 (mm)	P1 (mm)	P2 (mm)	W (mm)	Pin1 Quadrant
SOT-143	7"	9.5	3.20	2.80	1.30	4.0	4.0	2.0	8.0	Q3
SOT-23-5	7"	9.5	3.20	3.20	1.40	4.0	4.0	2.0	8.0	Q3

D00001

PACKAGE INFORMATION

CARTON BOX DIMENSIONS



NOTE: The picture is only for reference. Please make the object as the standard.

KEY PARAMETER LIST OF CARTON BOX

Reel Type	Length (mm)	Width (mm)	Height (mm)	Pizza/Carton
7" (Option)	368	227	224	8
7"	442	410	224	18

DD0002